



## Model: Visage Blinds

- Size: Custom
- Support Material: Aluminum
- Fabric: Custom Finish
- Installation: Optional
- Brand: NERVAL
- Warranty: Limited 1 year

Nerval Visage Blinds can be operated with manual cords or with motorized control. Nerval's Visage Blinds pair sheer with fabric vanes for superb light control, striking a perfect balance between form and function. Both the manual and the motorized options provide smooth, easy functionality.

## Features:

- Elegant, subdued look and quiet movement
- Outer sheer layers provide privacy, even when the vanes are open
- Perfectly symmetrical alignment of vanes
- Brackets offer adjustment for installations where leveling is needed
- Simple installation for both inside mount and outside mount
- Blind components are designed for quiet operation
- Hardwired & Battery operated motorization available
- Fabric wrapped fascia available to match the blind's vanes

Disclaimer: Nerval makes every effort to provide accurate specification data. However, specification may change without notice. Please visit nerval website to see NERVAL'S TERMS AND CONDITIONS.

## Hardware Details:

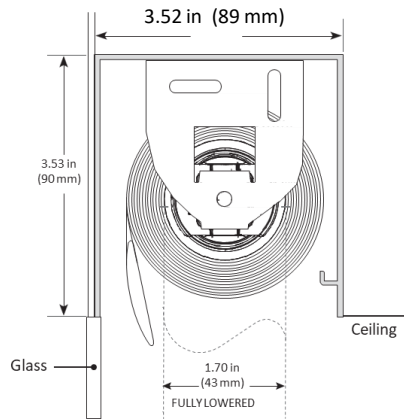
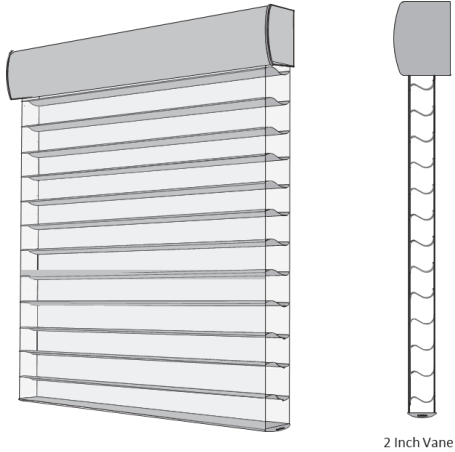

**Installed Profile: 2 inch Blind**  
(Fascia end caps and some other details omitted for clarity.)

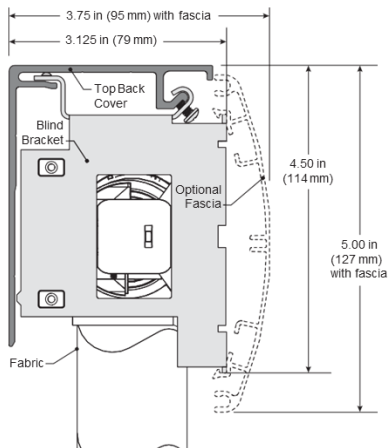

**Installed Profile: 3 inch Blind**  
(Fascia end caps and some other details omitted for clarity.)

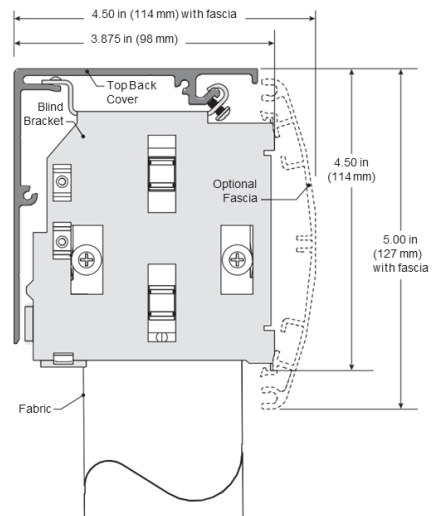

**NOTE:** Due to the fabric expansion in the fully-lowered position, a pocket flap cannot be used with Horizontal Sheer Blinds.

Disclaimer: Nerval makes every effort to provide accurate specification data. However, specification may change without notice. Please visit nerval website to see NERVAL'S TERMS AND CONDITONS.

## Mounting Options

Depending on the window dimensions, the shade can be mounted inside the window frame or outside the window frame.

### INSIDE MOUNT

To use inside mount, the window depth must be at least: 2 1/4 in (57 mm) for both 2 in and 3 in vane

For fully recessed installation, the window depth must be at least: 3 3/4 in (95 mm) for 2 in vane, 4 1/2 in (114 mm) for 3 in vane

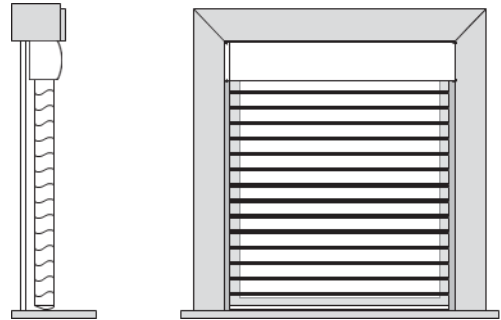

### OUTSIDE MOUNT ON TRIM:

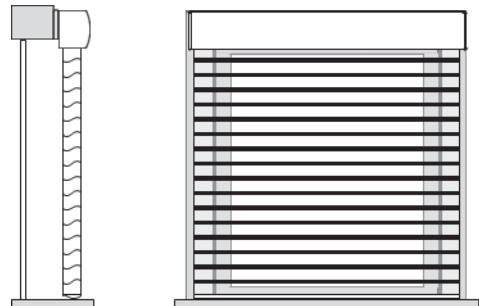

### OUTSIDE MOUNT ABOVE TRIM:

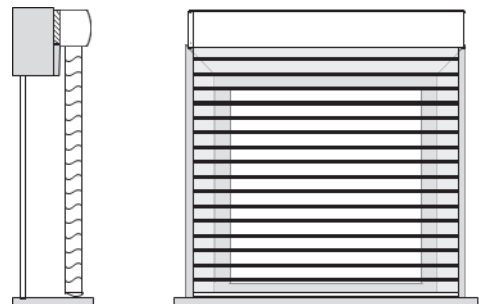

Disclaimer: Nerval makes every effort to provide accurate specification data. However, specification may change without notice. Please visit nerval website to see NERVAL'S TERMS AND CONDITIONS.